



# AQUAPRO OWNER'S MANUAL

4438 Muhlhauser Road

Suite 600

Hamilton, OH 45011

877-278-2797

# Attention Installer

**NOTICE: Read all instructions before installation.**

## **Unit is Pre-wired for 230 only!**

IF 208 VOLTS, PLEASE FOLLOW THE INSTRUCTIONS BELOW:

### **208VOLT/230V WIRING INSTRUCTIONS**

**ALL INSTALLATION AND WORK MUST BE PERFORMED BY A CERTIFIED ELECTRICIAN AND PER ALL LOCAL BUILDING AND ELECTRICAL CODES.**

**WARNING:** Before hooking up power to the main contactor, make sure the proper connections have been made to match the supply voltage on the supplied transformer. Using a voltmeter determine what the incoming voltage is. If 208V supply is being used, disconnect the factory lead (1) and reconnect it on (2) as noted in the pictures below. Failure to do so will result in voiding warranty, damage to the unit, fire, injury, or possibly even death.

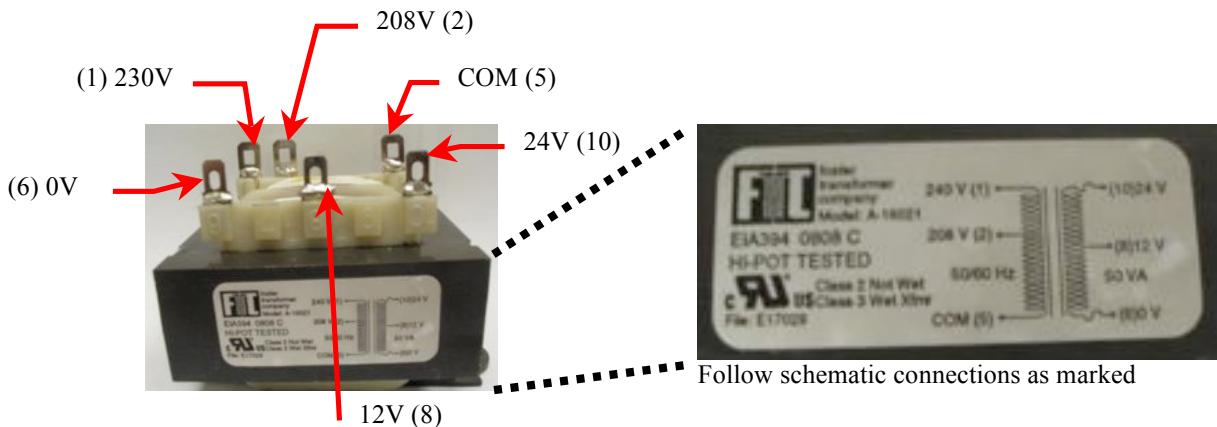

## **Water Pressure Switch Adjustments:** Plumbing Setups are Different

– A simple adjustment of the water pressure switch may be needed. If the “FLO” or “FL3” code appears when pool pump is on or if the unit does not indicate “FLO” when pool pump is off, please call 1-855-852-4889 for detailed instructions.

**FIELD WIRING:** NOTICE: To aid in field wiring, see the Figure 1 below. Incoming power is to be connected to L1 and L2 as shown. To insure proper connections tighten the screws securely to 40-45 in-lbs (4.5-5 N-m). After L1 & L2 Lugs are torqued, move wire side to side to settle wire strands, then torque again. Failure to do so may result in wires becoming loose which can result in voiding warranty, damage to the unit, fire, injury, or death.

## **Bonding & Grounding the Unit are Required.**

Failure to do so will result in voiding warranty, damage to the unit, fire, injury, or possibly even death.

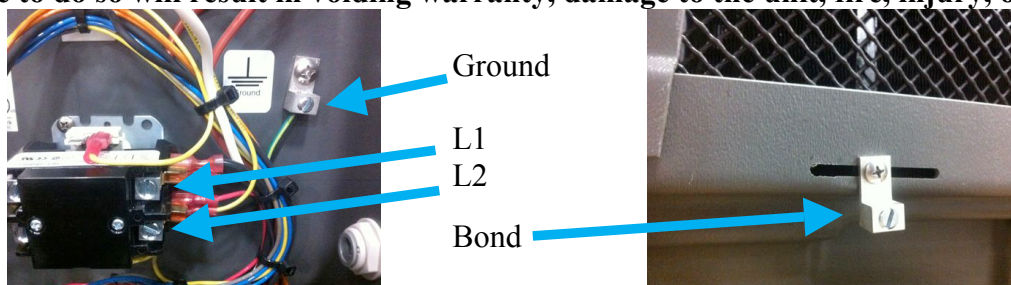

**Notice:** Please remove these instruction from the Electrical area and store with proof of purchase.

# Unit Setups:

Heat Pumps Require the Following:

(Please See Owner's Manual for All Details)

- Water Flow, Water Flow & Water Flow!!! (Require: 25 to 80GPM & Recommend: 40 to 80GPM) (Vary per Model)
- Proper Voltage (Switch Wire Location on Transformer if 208 Volts) See details on other side of this Document.
- Proper Ground and Bond per NEC Requirements.
- Level Pad & Allowance for Condensation Drainage
- Installed Outside with Clearance around the Heat Pump for Maintenance and Air Flow.
- No Roof Drainage on Heat Pump
- Any Additional Heater(s) (Solar, LP, Natural, etc...) must be Downstream of Heat Pump(s).
- Any Chemicals added (Chlorinators, Salt Generators, etc...) must be added Downstream of any Heater(s) with a Check Valve Separating them.

# Commercial & Multiple Heater Setups:

- Water Flow, Water Flow & Water Flow!!! (Require: 25 to 80GPM & Recommend: 40 to 80GPM) (Vary per Model)
  - \*Please Note: Due to Health Code Requirements Requiring a Mandatory GPM, Some Circumstances Request Restrict the Water Flowing throughout the Heat Pump(s) to Increase the Total Required GPM for the System... aka: HP Code. This can Results in Improper Water Flow Flowing throughout the Heat Pump(s) which can Result in High Electric Bills, Voiding Warranty, Loss of Performance, Over Heating the Heat Pump(s), Damage to the Unit, Fire, Injury, or Possibly Even Death. It is Required to have a Water Flow Meter on All Heat Pumps. A Water Flow Meter will Help Guarantee a Longer, Better Life & Performance of your Heat Pump(s).
- Proper Voltage (Switch Wire Location on Transformer if 208 Volts) See details on other side of this Document.  
\*\*\* Failure to do so will result in voiding warranty, damage to the unit overtime due to Overheating Components, fire, injury, or possibly even death.\*\*\*
- Proper Ground and Bond per NEC Requirements.  
\*\*\* Failure to do so will result in voiding warranty, damage to the unit, fire, injury, or possibly even death.\*\*\*
- Level Pad & Allowance for Condensation Drainage.
- Installed Outside with Clearance around the Heat Pump for Maintenance and Air Flow. \*\*\*Please Note: When Installing 2 Heat Pumps side-by-side, the Coil Clearance increases to 24" between Heat Pumps.
- No Direct Roof Drainage on Heat Pump.
- Any Additional Heater(s) (Solar, LP, Natural, etc...) must be Downstream of Heat Pump(s).
- Any Chemicals added (Chlorinators, Salt Generators, etc...) must be added Downstream of any Heater(s) with a Check Valve Separating them.
- For any questions regarding Plumbing Recommendations, Please Call Manufacture.

# Winterizing:

After shutting Down the Pool and (or) Spa with All Water Removed from the Plumbing/ PVC, Disconnect the Supplied Unions on the Front of the Heat Pump. Use an Air Blower to Blow the Water Out of the Heat Pump. The Air Blower has to be High Volume, but Low Pressure (like a Shop Vacuum in Reverse). Blow into the Inlet until the Water stops coming out of the Outlet, then Blow into the Outlet until water stops coming out of the Inlet. Cycle back and forth until No Water coming out in Any Direction. Start the Unions back on the Heat Pump to Prevent Dirt, Debris, Foreign Objects and (or) Bugs, Snakes, Mice, Lizards, Frogs, etc... from Entering the Heat Pump Plumbing.

\*\*\*For More Details: Please Refer to Owner's Manual or Contact the Manufacture with the Supplied Number on your Heat Pump Serial # Decal with the Serial # Available. Thank you\*\*\*



## **TABLE OF CONTENTS**

HOW A HEAT PUMP WORKS -----	1
SAFETY INFORMATION-----	2
QUICK START & STOP-----	4
HEATER CONTROLS -----	6
Control Panel Layout -----	6
Buttons, Lights, and Display -----	6
Operational & Programming Codes -----	7
Owner-Level Programming (complete) -----	8
MAINTENANCE AND GENERAL OPERATION -----	12
General Maintenance-----	12
Safety During Cleaning Operations -----	12
Maintaining Proper Water Flow -----	13
Controlling Water Chemistry -----	13
Controlling Irrigation and Storm Water Run Off -----	14
Maintaining Clearances Around Heater -----	14

*(Continued on Next Page)*

# **TABLE OF CONTENTS**

(CONTINUED)

## MAINTENANCE AND GENERAL OPERATION...CONTINUED:

Heating Tips-----	15
Heating in Cooler Weather-----	15
Pool/Spa Blankets-----	15
Pool & Spa Combination Heating-----	15
Spa Set-Back Option-----	15
Calculating Initial Heating Time-----	16
Seasonal Use & Shut Down-----	17
(Use) During the Swim Season-----	17
Freeze Protection and Winterizing Requirements-----	17
Winterizing Procedure-----	18
AquaPro Preventive Maintenance Program-----	19
TROUBLESHOOTING (No Op, No heat, Water from Unit)-----	20
Troubleshooting Flowcharts-----	21
CONTACTING THE FACTORY-----	24
LIMITED WARRANTY-----	25

# HOW A HEAT PUMP WORKS

THE FOLLOWING EXPLANATION IS PROVIDED TO HELP YOU IN UNDERSTANDING WHAT TO EXPECT FROM YOUR HEAT PUMP...

## **A Heat Pump Does Not Make Heat...**

Heat pumps are so extraordinarily efficient because they do not need to *produce* heat in order to warm pool or spa water. Rather, heat pumps simply *transfer* heat from the outside air into the water.

If one considers Absolute Zero (*the point where all heat is absent*) occurs at  $-459^{\circ}$  Fahrenheit, it becomes evident outside air, even at the relative cool temperature of  $55^{\circ}$  Fahrenheit, still contains large amounts of heat energy. It is that abundant heat energy a heat pump captures and places into your pool or spa.

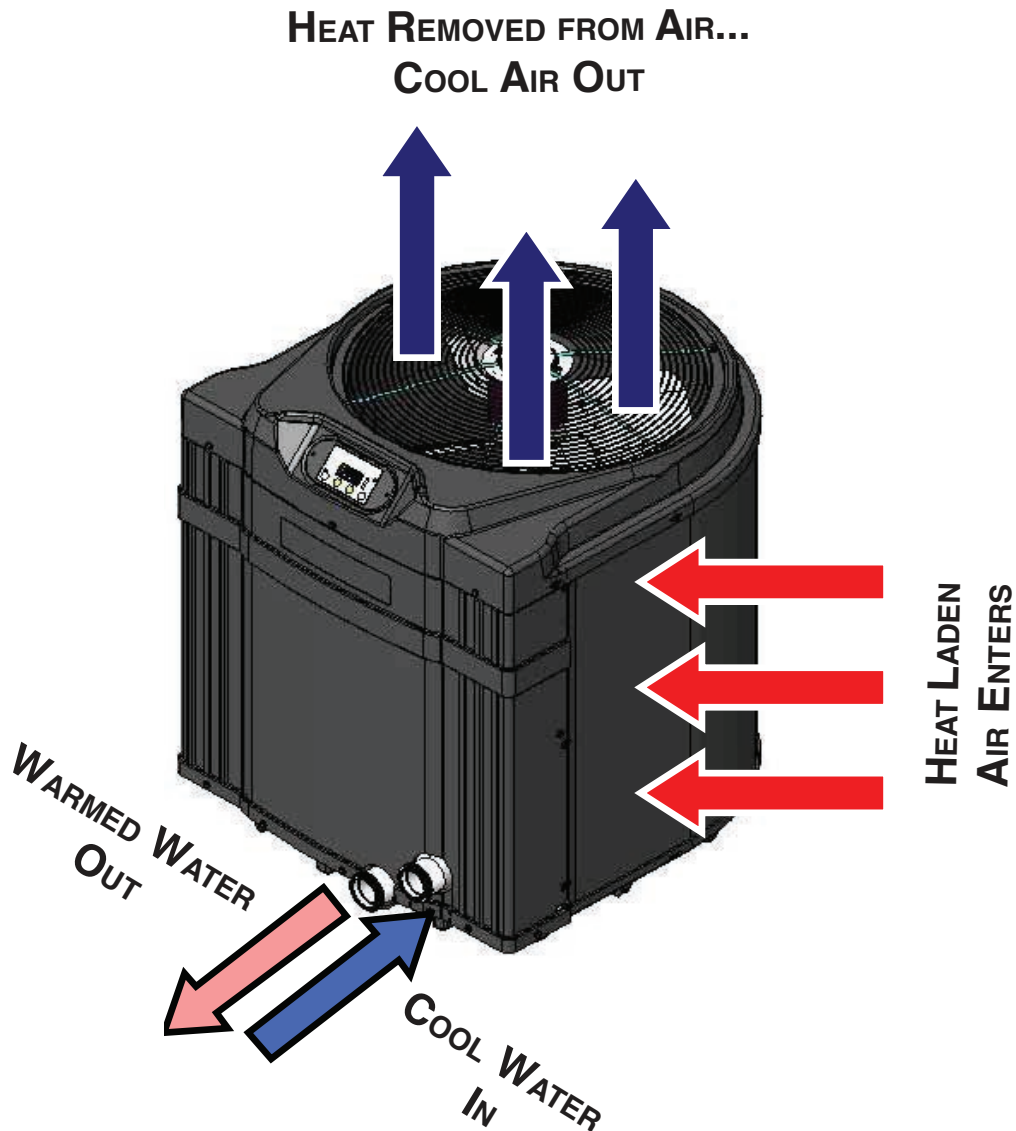

# SAFETY INFORMATION

Used and maintained properly, your heat pump will provide year-upon-year of safe and economical service. However, as with any mechanical or electrical device, to get the most from your heat pump—while insuring personal safety for you and others—certain operational and maintenance factors must be observed.

Likewise, excepting a few minor owner-capable maintenance items (explained later in this manual), repair and service of your heat pump must be performed only by experienced service personnel. Should you, the owner, suspect your heat pump is not performing properly, by referring to the section in this manual entitled: "Troubleshooting," you will be able to determine if a call for service is required. Your installer can be one source of service, or AquaPro Customer Support personnel stand ready to assist you at: (877) 278-2797. For questions concerning installation, modifications, operation, service and upkeep, please contact your installer or AquaPro Customer Support. Warranties may be voided if the heater has been used, maintained, or repaired improperly.

In addition to voiding the manufacturer's warranty... unapproved installation methods, nonstandard modifications, poor or incorrect maintenance, service by unqualified personnel, or improper use of the heater may result in personal injury and/or property damage. For personal safety, and to avoid damage to equipment, follow all safety instructions displayed on the heat pump and within this manual.

## Safety Signals

Throughout this manual the following two safety signals are placed where particular care is required. Please note "WARNING" relates to personal safety, while "CAUTION" signals promote avoiding damage to equipment.

### **WARNING !**

Failure to heed the following may result in permanent injury or death.

"Warning" signal appears in this manual where special attention is required for personal safety. *(Specific instructions will appear in this box.)*

### **CAUTION !**

Failure to heed the following may result in equipment damage.

"Caution" signal appears in this manual where special care is required to avoid equipment damage. *(Specific instructions will appear in this box.)*

## Notice: Heater NOT Repairable by Owner

### **WARNING !**

Failure to heed the following may result in permanent injury or death.

Heat pumps contain no owner-repairable components. Repairs must not be attempted by untrained and/or unqualified individuals. If service is deemed necessary, contact installing dealer or AquaPro Customer Support at (877) 278-2797.

## Refrigerant Circuit Service Only by Qualified, EPA Certified Technician

### **WARNING !**

Failure to heed the following may result in permanent injury or death.

Heater contains refrigerant under pressure. Repairs to the refrigerant circuit must not be attempted by untrained and/or unqualified individuals. Service must be performed only by qualified HVAC technicians. Recover refrigerant before opening system.

## Water Temperature Safety

### **WARNING !**

Failure to heed the following may result in permanent injury or death.

Prolonged immersion in water warmer than normal body temperature may cause a condition known as HYPERTHERMIA. The symptoms of hyperthermia include: unawareness of impending hazard, failure to perceive heat, failure to recognize the need to exit the spa, and unconsciousness. The use of alcohol, drugs, or medication can greatly increase the risk of fatal hyperthermia. In addition, persons having an adverse medical history, or pregnant women, should consult a physician before using a hot tub or spa. Children and the extreme elderly should be supervised by a responsible adult.

## Water Chemistry Safety

### **WARNING !**

Failure to heed the following may result in permanent injury or death.

Improper water chemistry can present a serious health hazard. To avoid possible hazards, maintain Pool/Spa water per standards detailed later in this manual.

### **CAUTION !**

Failure to heed the following can result in damage to equipment.

While your heat pump's titanium-based heat exchanger provides nearly impervious protection against poor water chemistry, improper water chemistry may cause expensive damage to pump, filter, pool shell, etc. To avoid equipment damage, maintain Pool/Spa water per standards detailed later in this manual.





## Getting Started

# HEATING- QUICK START & STOP

This brief information is provided as an aide to installers, service personnel, and owners. The intent of this section is to provide rapid access to very basic operational information. Individuals who will be routinely using, installing, maintaining, and servicing this heat pump, are strongly encouraged to read this entire manual. Herein, the terms: *Heat Pump*, *Heater*, and *Unit* are used synonymously. **These instructions are intended for local control of a heat pump, independent of an external controller. Owners: if your installation includes an external controller, contact your installing dealer, or the external controller manufacturer, for external controller operating instructions.**

These instructions are for quick-starting in the HEATING mode... **Owners of Heat-Cool units**, in order to utilize all features of their heater, will certainly want to also refer to: Owner Level Programming, beginning on page-14 of this manual.

### 1. Verify Electrical Power is Present at Heater:

- A. Ensure that the unit has electrical power connected; the heater controller display should be illuminated.
- B. If the display is blank, be certain the electrical breaker, and heater disconnect, are switched to "ON."
- C. For now, leave the water circulation pump OFF.

### 2. Set the Heater Controls (Refer to Control Panel Layout, Pg-12):

OWNER- If heater is connected to a Call-Flex controller, also see "Selecting Call-Flex Pump Options," located on page-17 of this manual.

INSTALLER- Is heater connected to an external controller? If so, see external controller information located on pages 41 and 44 of this manual.

- A. The user/owner settings can be made without water flowing. Once the heater has electrical power connected, with water *not* flowing, the display should read FLO.
- B. Press the MODE button until the HEAT (HEA) indication displays. This action will enable the remaining programming keys.
- C. Using the POOL / SPA selector key, select the POOL mode. An illuminated POOL indicator light, located on the left side of the display, will confirm the POOL control has been selected. If heating *only* a spa, using the DOWN arrow key, lower the POOL temperature until OFF is displayed; then proceed to Step-"E."
- D. Use the UP / DOWN arrow keys to set the desired water temperature for the POOL water.
- E. If the heat pump will be used to heat a spa, use the POOL/SPA selector key to select SPA, then use the UP / DOWN arrow keys to set the desired water temperature for the SPA. An illuminated SPA indicator light, located on the left side of the display, will confirm the SPA control has been selected. If heating *only* a POOL, using the DOWN arrow key, lower the SPA temperature until OFF is displayed.
- F. The heat pump controls are now set to maintain the desired water temperature for the POOL and/or SPA.

(Quick-Start & Stop Continued Next Page)



## **HEATING-QUICK START & STOP** (continued):

### **3. To Begin Heating:**

- A. Verify MODE is set to: HEAT (HEA); then, depending on which body of water is to be heated, use the POOL / SPA selector key to select POOL or SPA.
- B. Position water valves to flow water from the pool or spa, through the heater, and back to the pool or spa.
- C. Start the water pump; the fan will start, and after 4-minute time delay the unit will begin heating. The selected body of water will be brought to temperature and maintained per the setting determined previously in: "Set the Heater Controls."
- D. In operation, whenever the actual (displayed) water temperature falls below the desired set point, after an initial time delay of 4-minutes, the unit will begin heating.

NOTE: THE HEATER CONTROLLER INCORPORATES AN ANTI-SHORT CYCLE TIME DELAY. SHOULD OPERATION BE INTERRUPTED, COMPRESSOR RESTART WILL BE DELAYED BY APPROXIMATELY 4-MINUTES.

### **4. Program Filter Pump Run Time:**

Most pool/spa systems utilize a timer or multifunction controller to manage filter pump run times. If your system incorporates such a device, follow the instructions below:

- A. It will be necessary to allow the filter pump to run continuously until the water has reached the desired temperature. If a timer controls the pool filter pump, it will be necessary to override the timer to allow 24-hr. operation.
- B. Once the desired temperature has been obtained (1-4 days), reset the pump control device. Colder months require longer running times—generally eight to twelve hours/day.
- C. A heat pump can only operate when the filter pump is running. Therefore, it may be necessary—during cooler weather—to extend the water pump's hours of daily operation. The increased run time is necessary in order to keep up with increased, weather-related heat losses.

### **5. Continuous Usage and Water Around Heater:**

Condensation... After the heat pump has been operating for some time, water may be observed surrounding the heater. The moisture seen is condensation produced as a normal by-product of transferring heat from the air into the pool or spa water. Quantities of 6-8 gallons of water produced per hour are common if the air humidity is high. Conversely, a low humidity condition may result in no condensation being produced. (If water around unit seems excessive, to troubleshoot, see page-26, "Water Coming from the Heat Pump.")

### **6. To Stop the Heat Pump:**

- A. Select: OFF via the MODE selector. This method of shut down preserves the controller settings;
- B. An interruption of water flow—such as when a pump timer is in control—will also halt heat pump operation.

*(End... Quick-Start & Stop)*



# HEATER CONTROLS

## Control Panel Layout

(APPEARANCE VARIES BY MODEL)

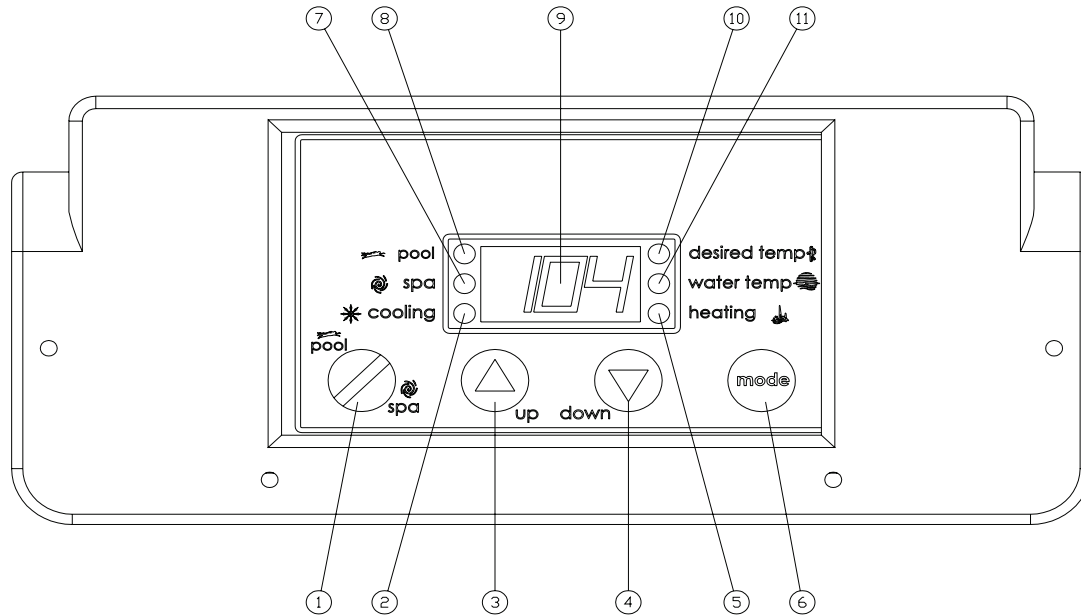

## Control Buttons, Indicator Lights, & Display

(AS INDICATED BY CIRCLED NUMBERS)

- 1) POOL / SPA SELECTOR** – Selects either pool or spa thermostat.
- 2) COOLING INDICATOR LIGHT** – Indicates unit is cooling. (Note: this light nonfunctional with heat-only models.)
- 3) UP ARROW** – Increases temperature setting. (Maximum setting is 104 °F)
- 4) DOWN ARROW** – Decreases temperature setting. (Minimum setting is 45 °F)
- 5) HEATING INDICATOR LIGHT** – Indicates unit is heating.
- 6) MODE SELECTOR** – Used to select between the Heating, Cooling, Auto-Changeover, and Off for Heat & Cool models. Used to select between Heating and Off for heat-only models.
- 7) SPA INDICATOR LIGHT** – Indicates heater is referencing spa thermostat.
- 8) POOL INDICATOR LIGHT** – Indicates heater is referencing pool thermostat.
- 9) LED DISPLAY** – Displays water temperature when no keys are being pressed. Displays desired temperature when UP ARROW or DOWN ARROW is pressed. Also displays operational, programming, and fault codes as applicable.
- 10) DESIRED TEMPERATURE LIGHT** – Indicates temperature set point is being displayed. Indicates temperature set point is being changed due to the UP ARROW or DOWN ARROW being pressed.
- 11) WATER TEMPERATURE LIGHT** – Indicates current water temperature is being displayed.



# HEATER CONTROLS...continued

## Operational & Programming Codes

THE FOLLOWING CODES WILL BE DISPLAYED AS PART  
OF THE NORMAL OPERATION OF THE HEATER:

- FLO.....** No Water Flow Detected. This code appears whenever the circulating pump is off, or when the heater is not receiving correct water flow.
- OFF.....** System is Off. This code appears whenever heater has been turned off via the mode selector button, or when the temperature set point has been lowered below 45 °F.
- CFI.....** Celsius/Fahrenheit Selection. This is a programming entry point to select in which format the water temperature will be displayed.
- ULC.....** User Lock Code. This is a programming entry point; when activated, steps to the next menu level: ELC.
- ELC.....** Enter Lock Code. This a programming entry point; permits end user to select a secret code, thereby limiting access to the owner settings.
- CFO.....** Call Flex Options. This is a programming entry point; when used in conjunction with an AquaCal Call/Flex add on kit, permits the use of CALL or FLEX options.
- FS.....** Heater in Defrost Mode (Applicable to Heat-Only Units, only). This code appears as a normal display during periods of lower air temperatures. Sequence follows:  
  
Heat-Only Defrost Sequence: Fan continues to run and compressor is off. Compressor will restart when air coil temperature rises to approximately 38°F.
- LOC.....** This is a Service Entry Point (not intended for use by the owner). The[LOC] code permits service personal to enter a factory code for access to adjustable calibration and site-dependant setup parameters. Service adjustments are available to authorized installation and service personnel, only.

### **CAUTION !**

Failure to heed the following may result in equipment damage and voiding of manufacturer's warranty.

Heat pumps contain no owner-serviceable components. Owner-initiated adjustments, beyond the controller "LOC" code, must not be attempted. If adjustments are deemed necessary, the owner should contact installing dealer or AquaPro Customer Support at (877) 278-2797.



# HEATER CONTROLS...continued

## Start Up & Setting Operating Controls

### Owner-Level Programming Instructions (Complete)

Covered within this section are features and settings typically accessed first by the installer, and then remaining accessible by the end user (the owner). These features reside at the Level-1 access point within the microprocessor. Note: if preferred, all programming may be performed without water flow, waiting to start the water pump as the last step in the set up and run process.

#### 1. Applying Power to The Controller:

- A. When power is first applied, the controller performs a lamp test and the display will read [888]. Following [888] the software version will display briefly.
- B. The control will then display the actual water temperature, provided the circulating pump is operating, and adequate water is flowing through the heater.
- C. If the pool-circulating pump is off, the control will display: [FLO]. This code message indicates no (or insufficient) water is being circulated through the heat pump.

#### 2. MODE Controls Explained, and Starting the Heat Pump:

- A. Once electrical power is supplied to the heat pump, sufficient water is circulating, and the heater controller has successfully completed its self-test, the heater is ready to operate.
- B. The heat pump is shipped with the controller [MODE] function set to "OFF". There are two ways to switch the heat pump OFF: First Method- One of the functions of the [MODE] button is "OFF". Second Method- The thermostat set point can be lowered to a position below the minimum temperature setting (45°F); this action will cause the display to read "OFF". To switch the unit ON, first use the mode button to select the HEAT mode—for Heat Only models—or, if the heat pump is a Heat and Cool model, use the mode button to select one of the following modes: HEAT, COOL, or ACH (Auto-Changer Over). In the [OFF] mode, the actual water temperature will be displayed as long as the circulating pump is operational and correct water flow is present. In the event water is not circulating through the heat pump (or flow is insufficient), the controller will display the [FLO] (No Water Flow) code message.
- C. Using the UP ARROW key, increase the desired temperature until it exceeds the value of the actual temperature displayed. (Note: See # "8," later in this section, if "000" is displayed upon pressing either the up or down arrow keys.) Once the desired temperature has been entered, the display will read the actual temperature and the heat pump will start to operate. Both the compressor and the fan must be operating before the "Heating" LED will illuminate. (Note: When MODE function is OFF, the current water temperature will be displayed; no functions, values, or programming will be available for adjustment.)

#### 3. Turning The Heat Pump Off:

- A. Method 1: using the [MODE] key, press the key until the display reads "OFF" The heater will shut off and remain off until the [MODE] key is used the select an operational mode. **This is the preferred method for shutting off the heat pump.**
- B. Method 2: using the DOWN key, press the key until the desired water temperature reaches 45°F (minimum setting); then, press the DOWN key one more time, causing the display to read "OFF". This method is typically used in conjunction with 2-wire external controllers; these controllers are equipped with their own thermostats.

*(Continued on Next Page)*



# HEATER CONTROLS...continued

## Start Up & Setting Operating Controls

### Owner-Level Programming Instructions... continued:

#### 4. Selecting Pool/Spa Thermostat Settings:

- A. Press the [POOL/SPA] key to toggle between the pool and the spa temperature set points.
- B. The pool/spa LED indicator lights, located to the left of the temperature display, will confirm the selected set point.

#### 5. Changing The Pool Temperature Set Point:

- A. Using the [POOL/SPA] key, select the POOL temperature set point. The pool set point indicator light will confirm the selection.
- B. The pool temperature set point is adjustable from a minimum of 45°F to a maximum of 104°F. Pressing the [UP ARROW] key will raise the set point 1-degree for every push of the button. Pressing the [DOWN ARROW] key will lower the set point 1-degree for every push of the button.

#### 6. Changing The Spa Temperature Set Point:

- A. Using the [POOL/SPA] key, select the SPA temperature set point. The spa set point indicator light will confirm the selection.
- B. The spa temperature set point is adjustable from a minimum of 45°F to a maximum of 104°F. Pressing the [UP ARROW] key will raise the set point 1-degree for every push of the button. Pressing the [DOWN ARROW] key will lower the set point 1-degree for every push of the button.

#### 7. Selecting Between °F and °C:

- A. Simultaneously press and hold both the [UP ARROW] and [DOWN ARROW] keys until [CF1] (Celsius / Fahrenheit) code appears.
- B. With the [CF1] code displayed, pressing the [UP ARROW] or [DOWN ARROW] keys will change the selection code to either "0" or "1". Select "1" for Fahrenheit temperature display, or "0" for Celsius temperature display. Once the desired temperature display mode has been selected, not pressing any buttons for 15-seconds will allow the controller to save the selection and return to the normal operating mode. Pressing the {POOL/SPA} key will also save the selection and step to the next menu parameter: [ULC] (User Lock Code).

#### 8. User Lock Code Option [ULC]:

##### This Option Explained:

Heat pumps are shipped from the factory with the [ULC] option disabled. Enabling the [ULC] function permits the heat pump owner to restrict access to the unit's controls. With the [ULC] function enabled, unless the correct ULC code number is entered, changes to Level-1 programming are not possible. (I.e.: Altering temperature set points, Pool/Spa selection, C/F display changes, etc., will not be possible). The [ULC] option can be thought of as an electronic lockable cover for the controls.

*(Continued on Next Page)*



# HEATER CONTROLS...continued

## Start Up & Setting Operating Controls

### Owner-Level Programming Instructions... continued:

#### 8. User Lock Code Option [ULC]...continued:

##### A. Selecting ULC Option:

- 1) Press either the UP or DOWN ARROW keys; if "LOC" is momentarily displayed followed by "0", the ULC feature is enabled. If "0" displays proceed to "6)" of this section; otherwise, see number "2," below.
- 2) Simultaneously press and hold both the [UP ARROW] and [DOWN ARROW] keys until [CF1] (Celsius / Fahrenheit) code appears.
- 3) Press the [POOL/SPA] key once to display [ULC].
- 4) With [ULC] displayed, pressing either the Up or Down Arrow key will display either "1" or "0". Selecting "0" will allow the keypad to remain unlocked. Selecting "1" will enable the User Lock Code option. Then, to enter a lock code number, press the [POOL/SPA] key once to display [ELC] (Enter Lock Code).
- 5) With [ELC] displayed, use the Up or Down arrow keys to select a lock code. The code can be any number from "00" to "99". The factory set lock code is "0". Not pressing any buttons for 15-seconds will allow the controller to save the selection and return to the normal operating mode. Pressing the [POOL/SPA] key will also save the selection, and will step the controller to the next menu parameter: [CFO] (Call Flex Options).
- 6) Once the ULC option has been enabled, pressing any key will momentarily display "LOC" followed by "0" (prompting the entry of the correct lock code number). To gain access to the controller:
  - a. Using the [UP ARROW] key, scroll to the correct lock code number, then;
  - b. Press the [POOL/SPA] key... Current water temperature will be displayed... Control setting can now be viewed or changed as desired.
  - c. After a period of approximately four (4) minutes, during which time no buttons have been pressed, the controller will automatically return to the locked mode. Provided ULC selection is set to "1," the controller will always fail-safe in the locked mode.
  - d. Without knowledge of the correct lock code, and with the ULC enabled, control adjustments will not be possible. **Be certain to record your lock code in a safe place.** The lock code may be changed any number of times by following the instructions detailed in this section.

##### B. De-Activating the User Lock Code [ULC] function:

- 1) Following the instructions detailed previously at: "8, 6)", press any key and enter the user lock code number; then press the [POOL/SPA] key.
- 2) Immediately following the entry of the user lock code, simultaneously press and hold the [UP ARROW] and [DOWN ARROW] keys until the code [CF1] appears on the display.
- 3) Then, use the [POOL/SPA] key to scroll to the [ULC] message; press the [DOWN ARROW] key to change the display to "0". This will disable the User lock function.

*(ULC Continued on Next Page)*



# HEATER CONTROLS...continued

## Start Up & Setting Operating Controls

### Owner-Level Programming Instructions... continued:

#### C. User Lock Code is Activated, but Pass Number is Not Known (“Back Door Entry”):

Note: Should the ULC option be enabled, and a lock code number other than the factory default (0) be installed but is unknown, the following procedure may be followed to regain controller programming access:

- 1) Simultaneously press and hold the [POOL/SPA] and [UP ARROW] keys until the display shows “888”. This operation will reset the controller to the factory default settings.
- 2) When reset to the factory default settings the user lock code [ULC] is deactivated and the user lock code number [ELC] is reset to “0.”
- 3) In addition, **all other settings are returned to the factory defaults**. If an external controller is in use, contact AquaPro Technical Support Group (877-278-2797); ask for assistance with re-configuring the controller for use with an external controller.

## 9. Selecting Call-Flex Pump Options [CFO]:

### General Information:

The Call-Flex option automatically adjusts the run time of the water circulator pump, and heater, based upon changing weather conditions. Without Call-Flex, as weather conditions grow progressively cooler during winter months, or when unusually cold weather occurs, the run duration of the circulator pump may require manual adjustments to permit the heater to maintain or reattain desired water temperature (the water pump must be running in order for the heater to operate). Likewise, without Call-Flex, one must remember to reset the pump run controls following the cold weather event. The Call-Flex option greatly reduces the need for seasonal, manually-made, pump run time adjustments. **Call-Flex is a dealer-installed option that does not come with every heater**; if unsure, check with the installing dealer to determine if a call-flex kit was part of the original installation. If Call-Flex was not part of the installation, and you would like to have Call-Flex added, your dealer can do so...contact the installing dealer.

If the installation is equipped with the Call-Flex option, the following steps are used to control the Call-Flex features:

- A. Simultaneously press and hold the [UP ARROW] and [DOWN ARROW] keys until the display shows “CF1”. Press the [POOL/SPA] key three times to scroll the display to [CFO].
- B. With the [CFO] (Call-Flex Options) code displayed, use the Up or Down keys to select “0” to disable the Call Flex Options, “1” to enable the Call Option, or “2” to enable the Flex Option. Not pressing any buttons for 15-seconds will allow the controller to save the selection and return to the normal operating mode. Pressing the [POOL/SPA] key will also save the selection, and will step the controller to the next menu parameter: [LOC] (Service Lock Code).
- C. For further information, please refer to Call-Flex installation instructions, shipped with the Call-Flex kit. For additional copies of these instructions, contact the AquaPro Customer Support (877-278-2797).

*(End... Owner-Level Programming Instructions)*





# MAINTENANCE & OPERATIONAL RECOMMENDATIONS

The information in this section is written primarily for the Home Owner, but may also apply to servicing dealers or HVAC service centers. This section contains information concerning planned maintenance, proper water flow, maintaining proper clearances, as well as other vital information. Please read this section now, and before calling AquaPro Customer Support (877-278-2797).

## **General Maintenance**

Heat pumps should be inspected and maintained on an annual basis by a qualified swimming pool heat pump specialist. Additionally, if the heat pump is located near the beach or coastal area, where salt spray and sand can become detrimental factors, more frequent service may be necessary. For service plan information, please see: Planned Maintenance Program, later in this section, and then contact AquaPro Customer Support at: 877-278-2797.

While annual maintenance is recommended to maintain your warranty, if you choose not to participate in the Planned Maintenance Program, rinsing the air coil regularly, and keeping the base of the unit clear of leaves and debris is a necessity.

Should you as the owner desire to perform the coil rinsing and other cosmetic care of the heat pump, please contact AquaPro Customer Support: 1-877-278-2797; request the document titled: "Appearance Care for Air-Source Heat Pumps: Approved Method for Home Owners."

## **Safety During Cleaning Operations**

### **WARNING !**

Failure to heed the following may result in permanent injury or death.

POSSIBLE ELECTRIC SHOCK HAZARD . . . Should you decide to wash the heat pump via water hose, disconnect all power to the pool equipment pad- including, but not limited to: The heat pump, water pump, and any and all other electrical equipment. Do NOT spray water directly into electrical components. Do NOT restore electrical power until such time as all water has dried completely.

### **CAUTION !**

Failure to heed the following may result in damage to equipment.

Do not use a pressure cleaner to wash heat pump . . . . Damage to evaporator fins, as well as other components, will result.



## MAINTENANCE & OPERATION (continued)

### Maintain Proper Water Flow

- It is important to operate and maintain the filter according to the manufacturer's specifications. As a filter gets dirty, the water flow to the heat pump is reduced. The higher the pressure on the filter gauge, the lower the flow rate.
- Similar to a dirty filter, large amounts of debris in the pump and skimmer baskets can reduce water flow. Keep baskets free of debris.
- Check for improper valve settings. A partially closed valve after the filter, or a full-open bypass around the heater, will cause insufficient water flow through heater.
- If the conditions listed above remain unresolved, the water flow through the heater may be reduced to a point where internal safety devices (i.e.: "HP" or "HP5") shut the heater off.
- Before calling for service, always check the filter, the pump basket, and water valve positions. If the problem persists, please call AquaPro Customer Support at: (877) 278-2797.

### Control Water Chemistry

- **IMPORTANT!** Your heat pump is engineered for exceptional durability and reliability. And, *this* unit's heat exchanger—being equipped with titanium tubing—will be nearly impervious to water chemistry damage. However, other components of the heater, and the remainder of the pool/spa equipment in general, may be susceptible to damage from prolonged exposure to unbalanced water chemistry. Likewise, bathers may be exposed to health risks if water chemistry is not properly maintained.
- For the longevity of the entire pool/spa installation, and for the safety of bathers, it is strongly recommended the water chemistry be checked regularly and maintained within proper norms. Please see the table, below, for a complete listing of recommended water chemistry levels.

#### RECOMMENDED WATER CHEMISTRY STANDARDS\*

Chlorine . . . . .	: 1.0 – 3.0 ppm in pools, 1.5 – 3.0 ppm in spas
Bromine . . . . .	: 2.0 – 4.0 ppm in pools, 3.0 – 5.0 ppm in spas
pH . . . . .	: 7.4 – 7.6 ppm in pools, 7.2 – 7.8 ppm in spas
Total Alkalinity . . . . .	: 80 – 140 ppm in pools, 80 – 120 ppm in spas
Calcium Hardness . . . . .	: 200 – 400 ppm in pools and spas
Total Dissolved Solids . . . . .	: 1,000 – 2,000 ppm in pools, 1,500 ppm above start-up TDS in spas

\* STANDARDS FOR COMMERCIAL APPLICATIONS MAY VARY LOCAL-TO-LOCAL...  
ALWAYS MAINTAIN WITHIN LIMITS ESTABLISHED BY AUTHORITY HAVING JURISDICTION.

#### CAUTION- Pool/Spa Refinishing Operations

During pool refinishing or acid cleaning, the water flow through the heater must be shut off. Water flow to the heater must remain off until water chemistry is once again in balance and the water is clear in appearance. Failure to follow these instructions may void heater warranty.



## MAINTENANCE & OPERATION (continued)

### Control Irrigation and Storm Run Off

- Control Irrigation: In regions where wells are used for irrigation, water quality is sometimes poor, and water spray can damage heater components. Regardless of water quality, it is important that irrigation be directed away from the heat pump.
- Prevent rain water runoff from pouring directly into the heater. The heater is designed to withstand normal rainfall, but solid streams of water from roof drip-lines may eventually damage heat pump components.
- If the heat pump resides beneath a roof edge, to promote heat pump longevity, a rain leader (gutter), or rain shield, will be necessary.

### Maintain Proper Clearances Around Heater

- For maximum efficiency, proper air flow clearances around heater must be maintained.
- It is important to keep the area immediately adjacent to the heat pump clear of items such as shrubs and bushes, lawn furniture, chemicals containers, etc. These items can prevent air from circulating fully through the heater, and will result in inefficient operation or damage to the heat pump.
- In addition, do not place objects on top of the heat pump; doing so will block the air from exiting the heater, and will result in damage to the compressor and fan motor.
- Proper clearances are also necessary in order to access the working parts of your heater. A heater that is easy to "get to," will be a heater that is easy to maintain; service and maintenance personnel will thank you for keeping the area around your heater unobstructed.
- Please see diagrams, below, for specific clearance requirements.

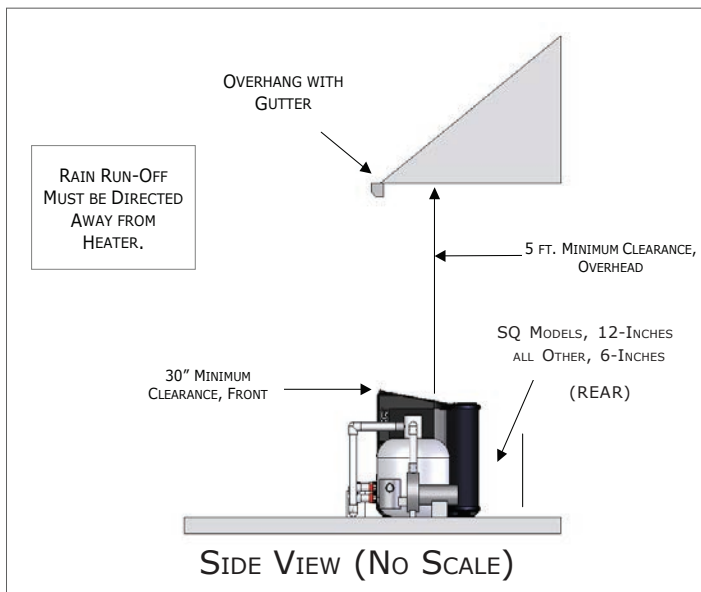

**FRONT-REAR-OVERHEAD**

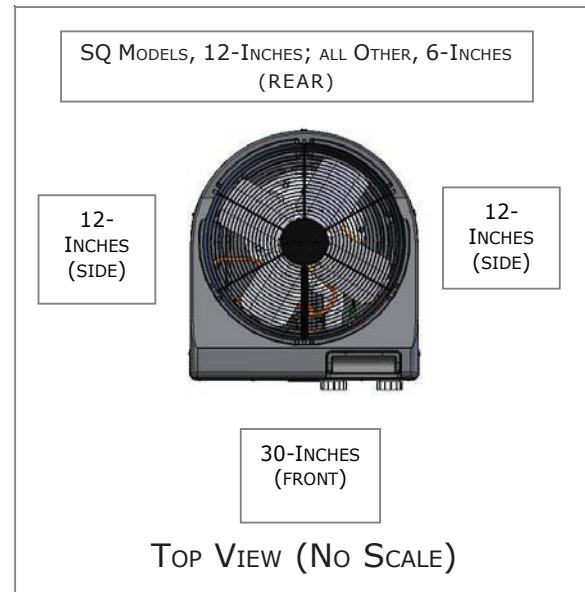

**FRONT-SIDES-REAR**



## **MAINTENANCE & OPERATION** (continued)

### **Heating Tips**

#### **Heating in Cooler Weather...**

Late night and early morning, generally being the coolest times of the day, are least efficient for heating. For most efficient heating operation, heat pumps should be timed to operate during the warmest, daylight portions of the day. Conversely, if cooling a pool, it is best to run the equipment at night. Please set water pump and heat pump controls accordingly.

#### **Pool/Spa Blankets...**

A “solar” blanket will significantly reduce your heating bills. Check with the installing dealer to see if your heat pump was sized to be used in conjunction with a blanket. Blanketed pools will typically lose only 3 - 4° of heat per night versus 8 - 10° overnight with an un-blanketed pool. Reductions of 40-60% on heating bills can be achieved by using blankets. (Idea...Contact AquaPro Customer Support (877-278-2797) to learn about Liquid Blanket innovations.)

### **WARNING !**

Failure to heed the following may result in permanent injury or death.

Improperly used, Pool-Spa blankets can become a drowning risk to people and pets. Blankets are not safety covers. They are not designed to support the weight of a person or pet. Never enter a pool until the blanket is completely removed (under no circumstances should anyone swim under the blanket). Follow all safety recommendations of the blanket manufacturer.

#### **Pool and Spa Combination Heating...**

Everything stated for heating a pool applies for heating a spa—only the volume of water being heated is different. Your heat pump comes equipped with two thermostats. One thermostat is for the pool and the other is for the spa. Simply position the pool and spa isolation valves as directed by your installer; select the appropriate thermostat (pool or spa), whichever you are heating, and with electrical power and water flow supplied to the heater, the water will be maintained at set point.

Your system can be automated with the addition of an optional External Flow Switch Kit (P.N. 0040S). Using this option will save you from having to change the thermostat selector switch each time you change from pool-to-spa and back again. Or, add a Universal Heater Controller (P.N. 0097TS) and gain not only automatic thermostat switching, but also automated spa/pool water valve operation. For details, contact the installer, the distributing dealer, or AquaPro Customer Support (877-278-2797).

#### **Spa Heating & Spa Setback Option...**

Air blowing into your spa, while it is being brought to temperature, will very often neutralize or partially counteract the heat being put into the spa by the heater; this added heat loss equates to increased time to bring your spa to desired temperature. When heating a spa, be sure to turn off the air blower. Air induced through the spa jets should also be eliminated, during warm-up, whenever possible.

If your heater is being used to *only* heat a spa, the POOL thermostat can be used as a setback control: simply set the pool control at a point 10-15° F below desired spa heat temperature and select the pool thermostat. This method allows the spa—when not in use—to be held at a heated temperature, but somewhat lower than normal spa-use temperature. One would want to blanket the spa if using this setback method. Using spa setback will result in reduced warm up periods over full, cold starts.



## MAINTENANCE & OPERATION (continued)

### Calculating Initial Heating Time

The time it takes to initially warm your pool or spa depends on several factors.

First, determine how many gallons of water are to be heated. Knowing this, you can then compute the equivalent pounds of water involved, and the BTU's necessary to heat the volume of water to the desired temperature.

Next, find the approximate BTU output of your heat pump at the current ambient air temperature; see product literature at: [www.ecoaquapro.com](http://www.ecoaquapro.com), or contact AquaPro Customer Support (877-278-2797).

Finally, decide upon the temperature at which you plan to maintain your pool or spa.

The following work sheet can be used to calculate approximately how long it will take your heater to bring your pool or spa up to temperature. Keep in mind heating times will vary somewhat due to weather conditions during the period that the heater is in use; use of a pool blanket can dramatically improve heat up and heat maintenance performance.

Pool Volume (Length X Width X Average Depth) = \_\_\_\_\_ Pool Cubic Feet

X Gallons per cubic ft.(7.5) = \_\_\_\_\_ Pool Gallonage

X Pounds per Gallon (8.3) = \_\_\_\_\_ Pounds of Water

How many degrees do you want to raise the temperature of the pool?

# of Degrees \_\_\_\_\_ X Pounds of Water (per above) = \_\_\_\_\_ BTU's Required

BTU's Required (per above) \_\_\_\_\_ ÷ BTU Output of Heater = \_\_\_\_\_ Hrs. of Operation

Optional Cold Weather Adjustment Factor:

Hrs. of Operation (per above) \_\_\_\_\_ X 1.25 (60° F outside air (O.A.) Temperature Factor) =

\_\_\_\_\_ Hrs. of Operation at 60° F O.A.

### **At Start Up: Continuous Circulator Pump Operation Required**

When starting a heat pump for the first time, it must be permitted to operate, continuously, until the desired water temperature is attained. This may take several hours, to several days, depending upon the size of the pool or spa and weather conditions.

If a time clock or similar device controls the operating times of the water circulating pump, temporarily override the water pump controller, allowing for 24-hour, continuous water pump operation.

Once the body of water has reached the desired temperature, the water pump controller can be reset.



# MAINTENANCE & OPERATION (continued)

## Seasonal Use & Shut Down

### During the Swim Season:

- During the swim season, even if the pool or spa is not in use, allow water to flow through the heater. Doing so eliminates the need to reposition valves when you do wish to heat the pool or spa.
- During periods when heating or cooling is not desired, leave heater controls in the OFF position.

# Important !!!

## Information Critical to the Survival of Your Heater Follows...

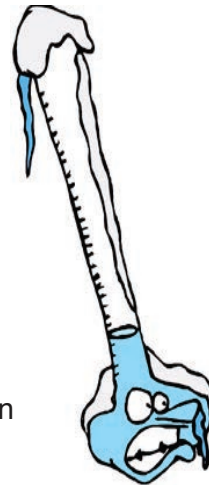

### Freeze Protection & Extended Shut Down:

In areas where freezing conditions are a rare occurrence, allow the filtration system to run continuously throughout the freeze period. Typically, during light freeze conditions, circulating (moving) water will not freeze.

In areas where freezing conditions are prevalent and sustained, the heat pump MUST be winterized; please refer to winterizing instructions, below, and on the following pages.

### Winterizing for Hard Freeze Conditions:

#### **CAUTION !**

Failure to heed the following can result in damage to equipment and/or property.

Failure to properly winterize heat pump may result in serious equipment damage. Freeze damage is not covered under the heat pump warranty.

#### **CAUTION !**

Failure to heed the following can result in damage to equipment and/or property.

While the plumbing connections are in the winterized condition (not fully tightened), it is imperative pool/spa water not be circulated through the heat pump. Loss of water through loose plumbing connections may result in damage to circulating pump, pool/spa structure, and/or other equipment.

*(Winterizing continued on page following)*



## MAINTENANCE & OPERATION (continued)

### Winterizing Procedure:

1. Disconnect all electrical power to the heater; turn OFF circulating pump.
2. At the two (2) connection unions, disconnect the plumbing to the heater (removal is counter-clockwise).
3. Locate the hand drain plug at lower, front corner of heater. See figure below. (position may vary between models). Remove plug.
4. Permit all of the water to drain out of the condenser and then replace the plug; thread the plug in clockwise until just snug, then apply an additional 1/8 turn.
5. To prevent insects and vermin from entering the plumbing during the winterized period, partially reconnect the two (2) plumbing connection unions: couple each union one or two threads; this will permit condensation to drain, but will prevent most insects and animals from entering the plumbing circuit.
6. Next Season: To ready the heat pump for use, simply retighten plumbing connection unions. Hand-tight is generally sufficient.

### LOCATION OF EXTERNAL DRAIN PLUG

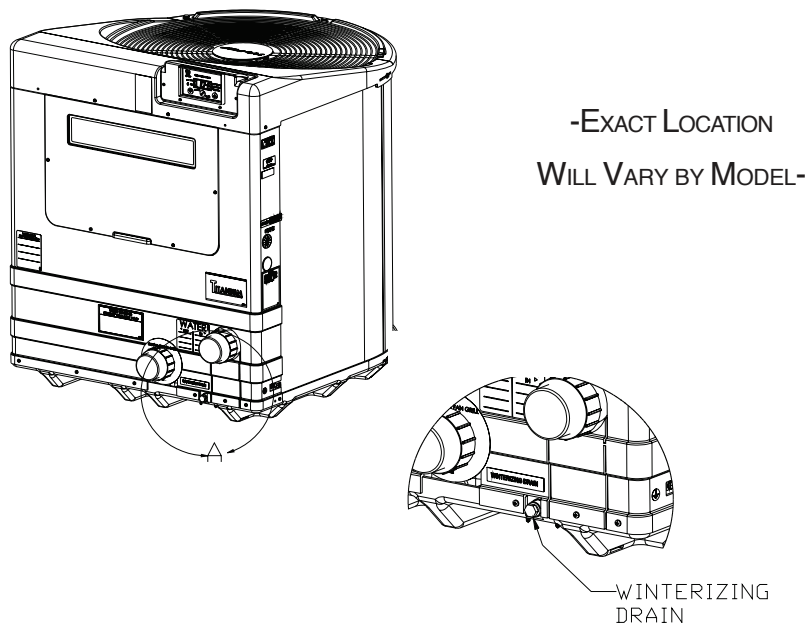

## CAUTION !

Failure to heed the following can result in damage to equipment and/or property.

While the plumbing connections are in the winterized condition (not fully tightened), it is imperative pool/spa water not be circulated through the heat pump. Loss of water through loose plumbing connections may result in damage to circulating pump, pool/spa structure, and/or other equipment.



## **MAINTENANCE & OPERATION** (continued)

### **Planned Maintenance Program**

Just as you would have yearly service performed on your air-conditioning system, regular inspection and maintenance of your AquaPro heat pump will insure highest operating efficiencies. A regularly maintained heater will protect your investment, and will potentially extend the useful life of your heat pump far beyond the warranty period. Our expertly trained factory service technicians offer comprehensive maintenance procedures designed to insure your heat pump—over the coming years—will continue to operate efficiently and reliably.\*

#### **The 20-Point Planned Maintenance Service Includes the Following:**

- > Check Water Flow
- > Clean Evaporator Coil
- > Check Relay Contacts
- > Check Capacitor Values
- > Check Refrigerant Levels
- > Clean Heat Pump Cabinet
- > Check Fan Blade Clearances
- > Check Flow/Pressure Switch
- > Check Electrical Connections
- > Check Proper Voltage To Unit
- > Oil Fan Motor (As Applicable)
- > Check Fan Motor Amperage Draw
- > Check Pool & Spa Water Chemistry
- > Check and Clean Condensate Drains
- > Check Compressor Amperage Draw
- > Check Water Pump Amperage Draw
- > Acid Wash Source Coil (As Applicable)
- > Check Air Temperature Change Through Evaporator
- > Check Operating Controls and Temperature Sensors
- > Check Water Temperature Change Through Condenser

We recommend Preventive Maintenance be performed starting one (1) year after the installation of the heater.

\* FACTORY PM SERVICE NOT AVAILABLE IN ALL REGIONS; PLEASE CONTACT AQUAPro CUSTOMER SUPPORT FOR ADDITIONAL INFORMATION (877) 278-2797.





# TROUBLESHOOTING

Also see page 51...  
"Error Codes"

## Heat Pump Fails to Operate...

### *Is the display illuminated?*

If not, ensure the main breaker (located at the power supply panel) and the disconnect switch (located near the heat pump) are both turned ON.

### *Is the code "FLO" displayed?*

If so, check to be sure that the circulating pump is operating and the filter is clean. There may also be a valve positioned incorrectly allowing water to bypass the heat pump. Be sure water is flowing through the heater.

### *Is the Pool or Spa thermostat selected for the correct body of water to be heated, and have you tried selecting a higher temperature setting?*

If not, the actual water temperature may be above that of the selected thermostat. Raise the desired water temperature above the actual water temperature; the fan should start, and after approximately four (4) minutes, the "Heating" light should illuminate. If the heat pump still fails to start, and the unit is not in defrost (heat-only unit defrost display code is: "FS"), contact AquaPro Customer Support: 877-278-2797.

## Heat Pump Running... but is it Heating?

### *Is the air blowing out of the top of the unit noticeably cooler than the surrounding air?*

(With heating indicator light illuminated, a 9°F to 12°F difference is typical.) If not, contact AquaPro for service at: 877-278-2797. But first, be sure all air coil surfaces are free from obstructions—low roof overhangs, landscaping, walls, fences, etc., can restrict air flow. The heat pump needs good airflow to operate at peak efficiency.

### *How many hours/day does the circulating pump operate?*

Cooler weather conditions, or heating to a higher than normal temperature, may necessitate running the heat pump for a longer period of time. Was the heater sized considering the use of a pool blanket (check with installing dealer)? A blanket can be useful in permitting shorter run times, in turn leading to substantial energy cost savings.

### *What is the outside air temperature?*

The heat pump may be in the defrost mode if air temperatures are below 50°F. With Heat-Only models, if the heater is in defrost, the code: "FS" will be displayed. If air temperatures are not cold, but the heater remains in defrost, contact AquaPro Customer Support at: 877-278-2797.

## Water Coming from the Heat Pump...

### *Is it a leak or just condensation from normal operation? Here's how to find out.*

Test the water draining out the heater base for the presence of the sanitizer being used in the pool or spa. Using a water test kit, or a test strip, check a sample of the water for chlorine or bromine. If the sample tests positive for sanitizer, call AquaPro for service at: 877-278-2797. If the test is negative, the water is probably harmless condensate.

Or, as an alternate method, shut the heat pump off, leaving the circulation pump running. Within a few hours, there should be a marked reduction in the amount of water seen around the bottom of the heat pump. If the water appears to be drying up, the water is probably harmless condensate, indicative of normal operation.

**NOTE:** The water test method will not be effective if an ionizer or ozone generator is being used to produce the sanitizing agent.

**CAUTION!** If after testing, a water leak is suspected, immediately shut OFF the water pump and contact AquaPro Customer Support: 877-278-2797.



# TROUBLESHOOTING FLOWCHART

## Heat Pump Fails to Operate

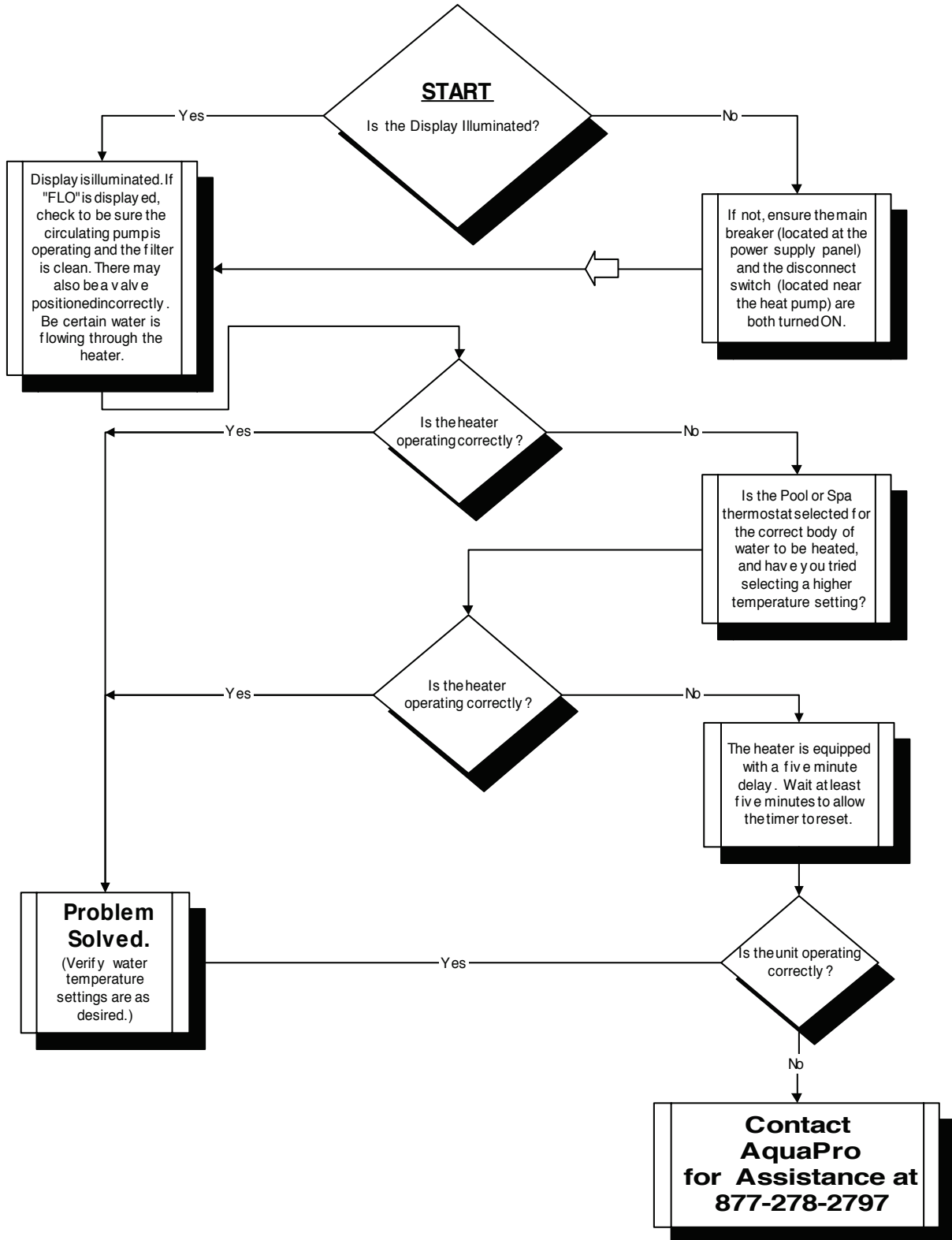



# TROUBLESHOOTING FLOWCHART

## Heat Pump Running... but is it Heating?

(Assumes Heating Indicator Light is Illuminated)

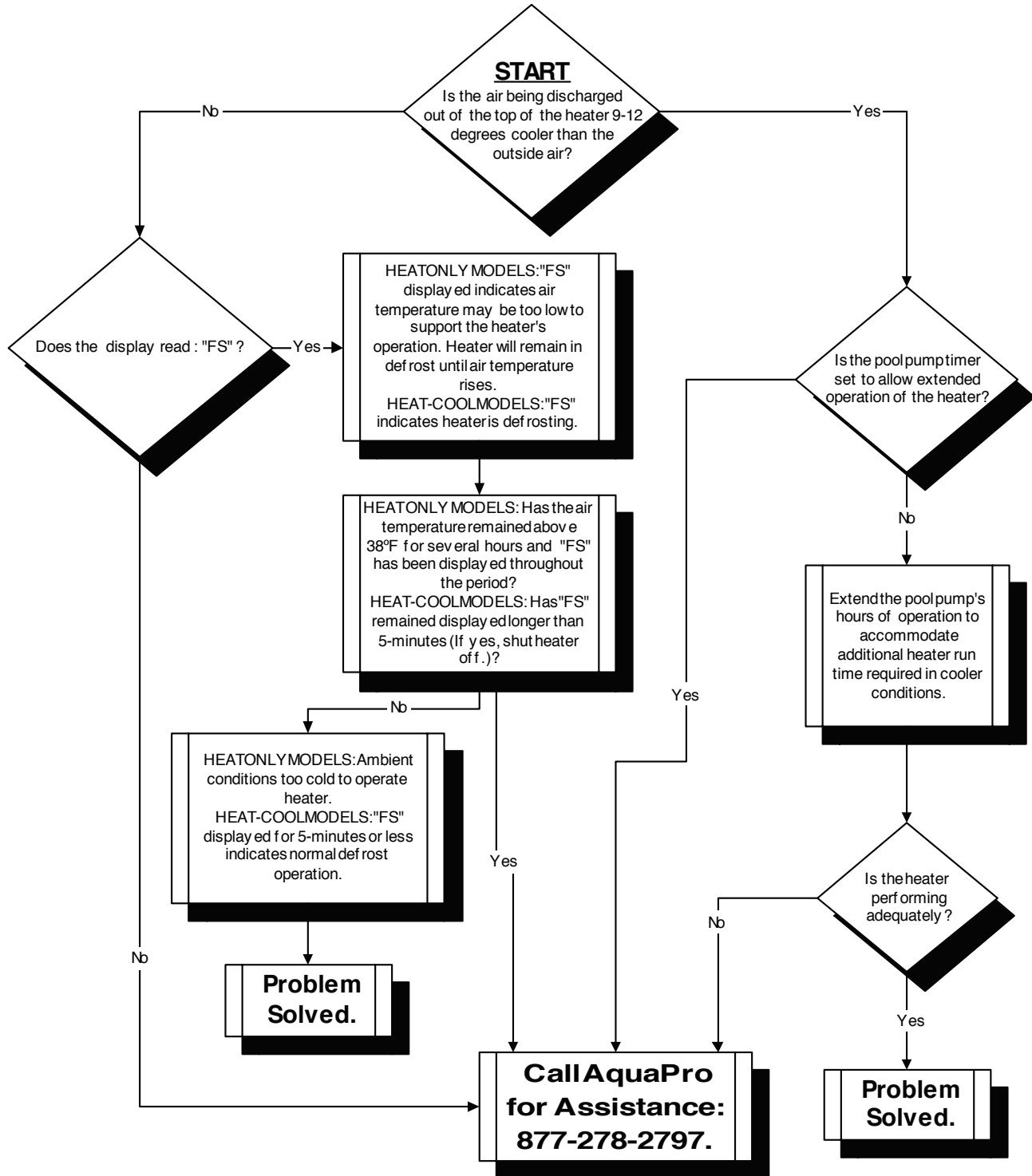



# TROUBLESHOOTING FLOWCHART

## Water Coming from Heat Pump

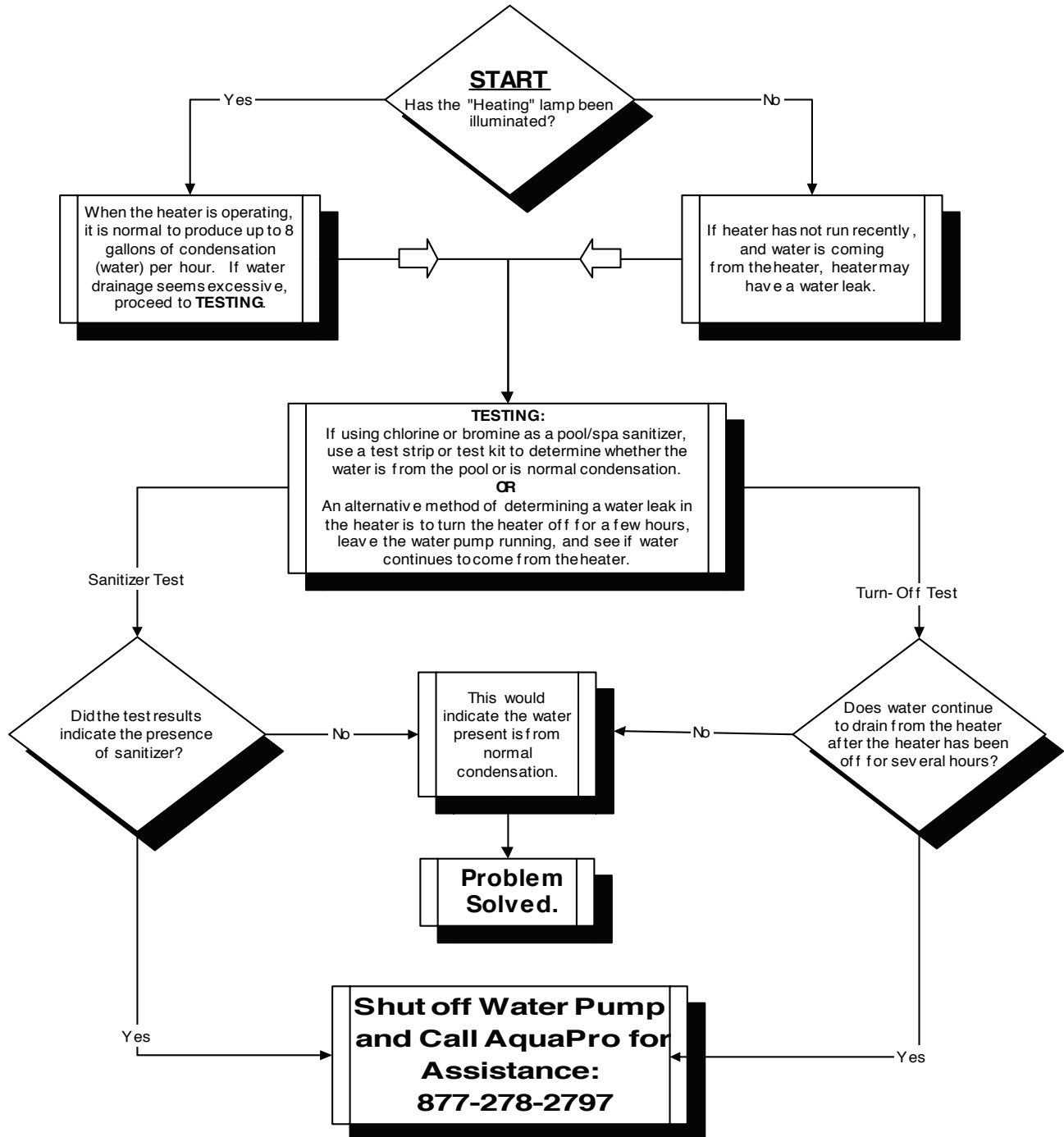



# CONTACTING THE FACTORY

## What We Need to Know When You Call Us

If you should need to call AquaPro for service or parts, please have the following information ready:

Model: \_\_\_\_\_

Serial Number: \_\_\_\_\_

Installation Date: \_\_\_\_\_

} Look for this information on sticker located at top of front cover of this manual; otherwise, see data plate on side of heater.

} Refer to installer's invoice for this information.

Having the above information ready will speed the service process and allow us to respond more quickly. A brief but concise description of what the unit is, or is not doing, will also help us to help you.

Please call toll-free at: (877) 278-2797. We are here to serve you from 8 a.m. to 5 p.m. EST, Monday through Friday. If calling after hours, our voice mail system will handle your call. Be sure to leave your name, complete address, and telephone number.

If you prefer, you may FAX the information to: (888) 610-3839.  
(Be certain to provide your full address and a daytime telephone number.)

## Thank You !



---

## LIMITED WARRANTY

For (7) years for the state of Florida and (2) years for all other US states and Canada, Heating Solutions, LLC will repair or replace, at its option, for the original owner any parts of its Heat Pumps ("Product") which are found upon examination to be defective in materials or workmanship; for residential application - as defined as a single unit. This Limited Warranty covers labor for a period of two (2) years for Product installed and sold within the state of Florida and Arizona, for (1) year for product sold and installed in all other US states and Canada.

For five (5) years from the date of purchase, Heating Solutions, LLC will repair or replace, at its option, for the original owner, the compressor (part only), found upon examination to be defective in materials or workmanship, for residential applications. The manufacturer's Titanium Heat Exchanger carries a lifetime warranty on the titanium tubing part only. Therefore, this warranty for the Titanium Heat Exchanger will NOT be void due to unbalanced or improper pool chemistry. This warranty for the Titanium heat exchanger WILL be voided if chemicals are added upstream of the heat pump. Units must be bonded; check valves for salt.

For commercial applications, as defined as installations with more than one pool heat pump, this warranty (parts, labor, compressor & titanium) is reduced to one year from the original purchase date. To enable a commercial site to have residential limited warranty, the installer must: install water flow meters inline for every heat pump, provide & confirm via product registration within 60 days of installation confirmation of power input (240V or 208V), plumbing configuration, and unit spacing to ensure proper airflow.

Please call 1-877-278-2797 for instructions. Be prepared to provide the model number and serial number when exercising this limited warranty.

Purchaser must pay all transportation charges on products or parts submitted for repair or replacement. If a local warranty center requires a service fee for inspection of the model, this charge will be the responsibility of the homeowner.

All non-warranty service charges are the responsibility of the original owner. Failure to pay for non-warranty service charges will void this Limited Warranty.

This Limited Warranty does not cover Products that have been damaged as a result of accident, abuse, misuse, neglect, improper installation, improper maintenance or failure to operate in accordance with written instructions. All maintenance and service must be performed by service agents approved. Any unauthorized alteration or repairs will void this Limited Warranty.

**THERE IS NO OTHER EXPRESS WARRANTY, IMPLIED WARRANTIES, INCLUDING THOSE OF MERCHANTABILITY AND FITNESS FOR A PARTICULAR PURPOSE, ARE LIMITED TO ONE(1) YEAR FROM THE DATE OF PURCHASE. THIS IS THE EXCLUSIVE REMEDY AND ANY LIABILITY FOR ANY AND ALL INDIRECT OR CONSEQUENTIAL DAMAGES OR EXPENSES WHATSOEVER IS EXCLUDED.**

Some states do not allow limitations on how long an implied warranty lasts, or do not allow the exclusions or limitations of incidental or consequential damages, so the above limitations might not apply to you. This limited warranty gives you specific legal rights, and you may also have other legal rights which vary from state to state. In no event, whether as a result of breach of contract warranty, tort (including negligence) or otherwise, shall or its suppliers be liable for any special, consequential, incidental or penal damages including, but not limited to loss of profit or revenues, loss of use of the products or any associated equipment, damage to associated equipment, cost of capital, cost of substitute products, facilities, services or replacement power, downtime costs, or claims of buyer's customers for such damages.

This Limited Warranty does not include freight charges for equipment or component parts, to and from the factory, services such as maintenance or inspection, repair or damage due to negligence such as freezing conditions, incorrect installation, nor acts of God. It also does not include refrigerant or other expendable materials. The liability of shall not exceed the repair or replacement of defective parts under this Limited Warranty. This Limited Warranty also does not include unnecessary service calls due to erroneous operational reports, external valve positions, improper installation & lack of bonding, or electrical service. If a nonwarranty service call is made, and the homeowner is unwilling to pay for the service call, this Limited Warranty will be voided. This Limited Warranty is voided if the product is repaired or altered by any persons or agencies other than those authorized by Heating Solutions LLC. This Limited Warranty applied only within the continental USA. For warranty outside the continental USA, please contact the factory.

You MUST retain your purchase receipt along with this form. In the event you need to exercise a warranty claim, you MUST present a copy of the purchase receipt at the time of service. Please call 1-877-278-2797 for service or return authorization and instructions.

DO NOT MAIL THIS FORM. Use this form only to maintain your records.

MODEL NO. \_\_\_\_\_ SERIAL NO. \_\_\_\_\_ INSTALLATION DATE \_\_\_\_\_